

01		A3		17		A3	
02		A3		18		A3	
03		A3		19		A3	
04		A3		20		A3	
05		A3		21		A3	
06		A3		22		A3	
07		A3		23		A3	
08		A3		24		A3	
09		A3		25		A3	
10		A3		26		A3	
11		A3		27		A3	
12		A3		28		A3	
13		A3		29		A3	
14		A3		30		A3	
15		A3		31		A3	
16		A3		32		A3	

NOTE

- 1.
- 2.
- 3.

PARTICULARS

CLIENT

PROJECT TITLE

DRAWING TITLE

CHIEF DESIGNER

MASTER DESIGNER

DESIGNER BY

DRAWN BY

CHECK

VERIFY

APPROVE

DESIGN NO

PROJECT NO

CLASSIFICATION

DRAWING NO

SCALE

1:80

DATE



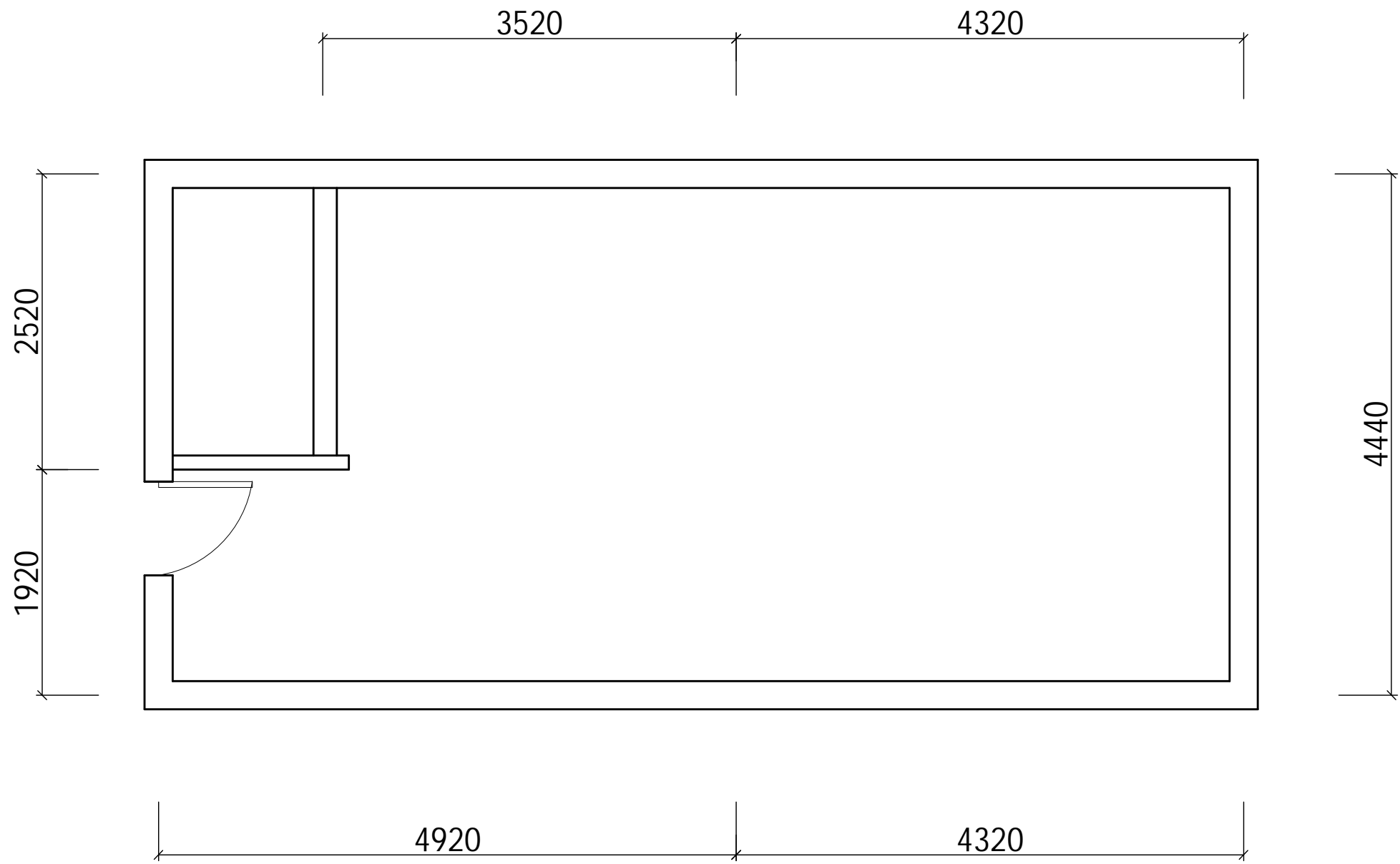

Phonvannin zannhphn Anvphnvn Phvnvn T+1

NOTE

- 1.
- 2.
- 3.

PARTICULARS

CLIENT

PROJECT TITLE

DRAWING TITLE
02

CHIEF DESIGNER

MASTER DESIGNER

DESIGNER BY

DRAWN BY

CHECK

VERIFY

APPROVE

DESIGN NO

PROJECT NO

CLASSIFICATION

DRAWING NO

SCALE

1:50

DATE



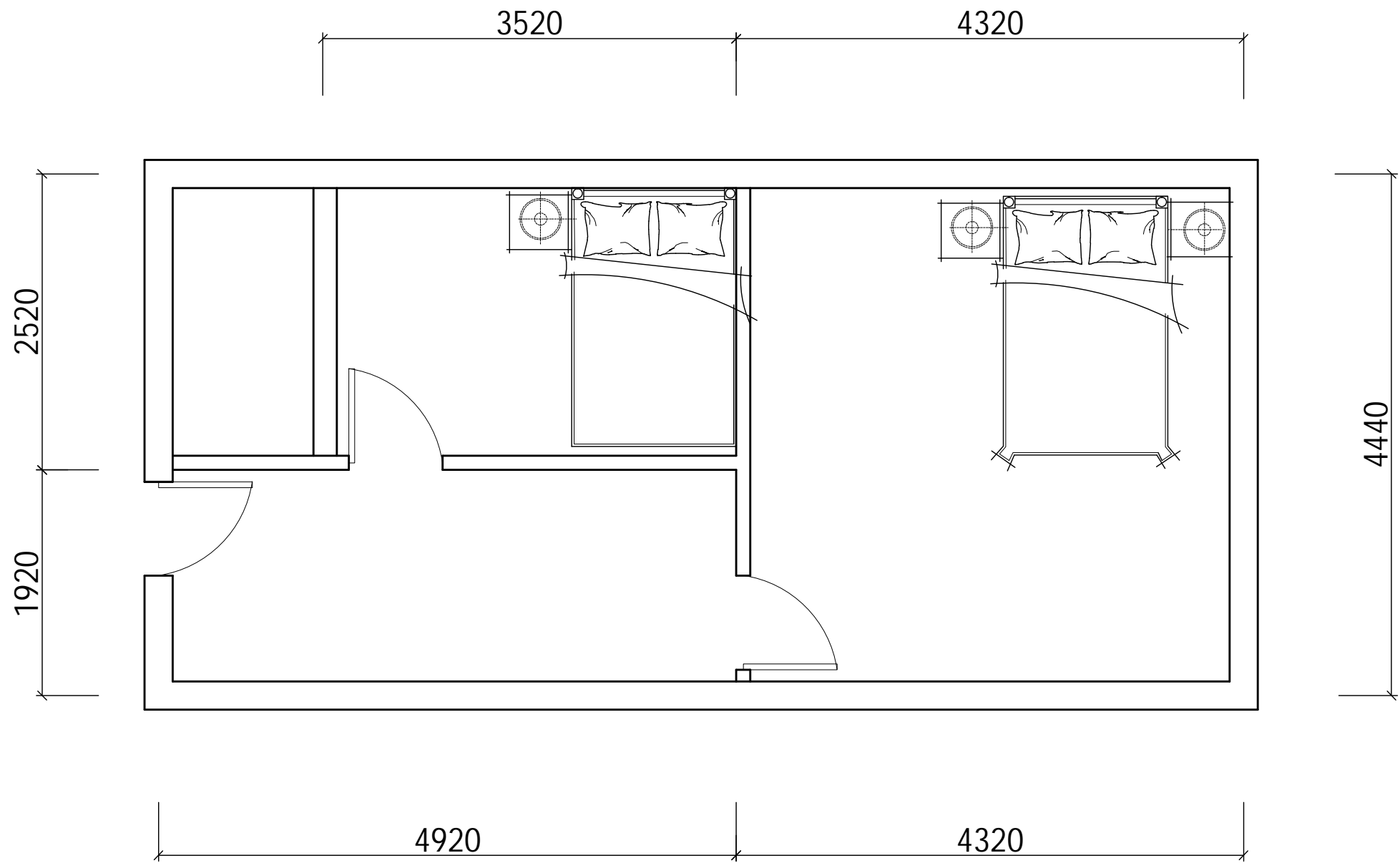

Phonvaine zandhous Architectuur Bvba

NOTE

- 1.
- 2.
- 3.

PARTICULARS

CLIENT

PROJECT TITLE

DRAWING TITLE
03

CHIEF DESIGNER

MASTER DESIGNER

DESIGNER BY

DRAWN BY

CHECK

VERIFY

APPROVE

DESIGN NO

PROJECT NO

CLASSIFICATION

DRAWING NO

SCALE

1:50

DATE



1		

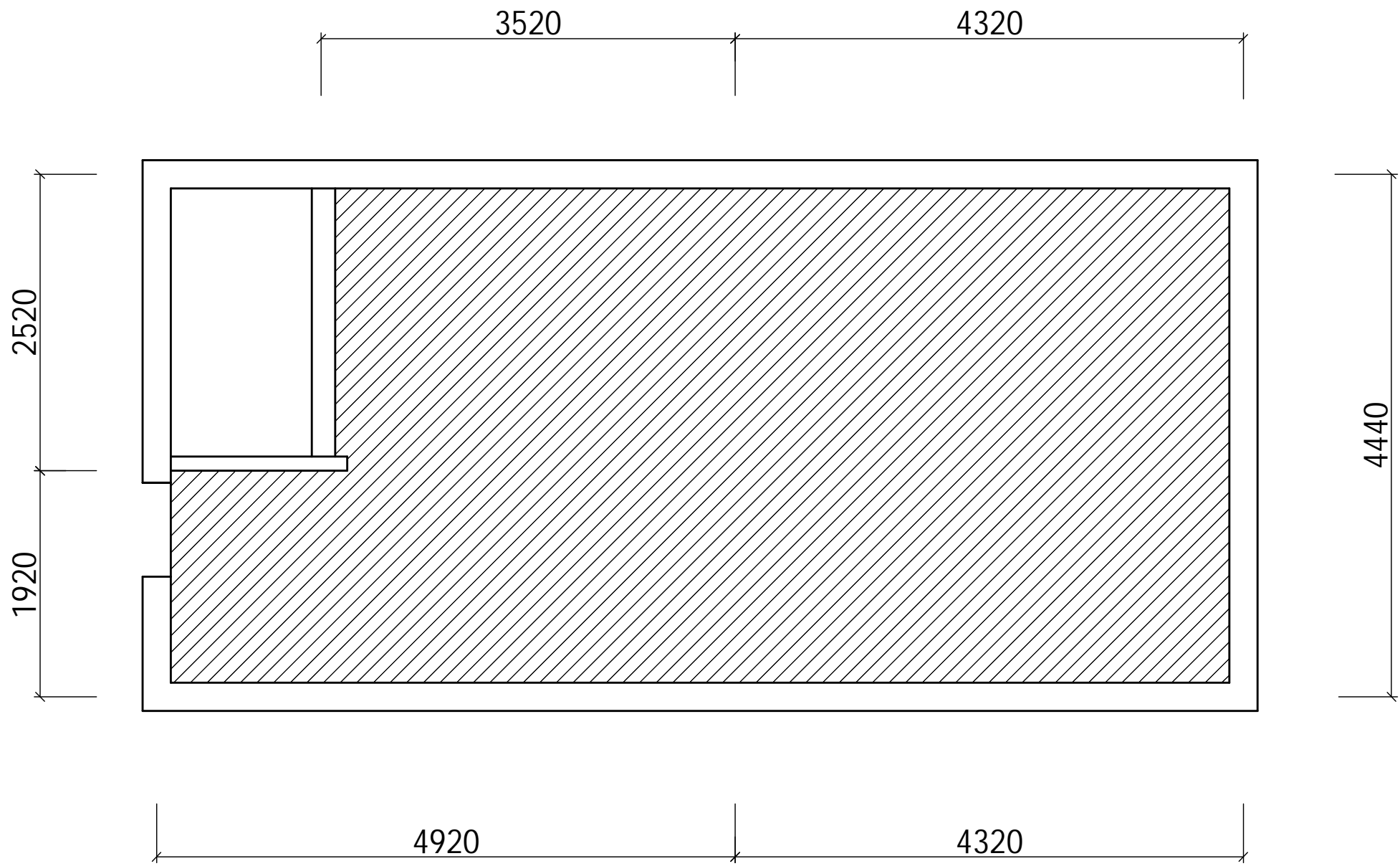

Chennai Engineering College

NOTE

- 1.
- 2.
- 3.

PARTICULARS

CLIENT

PROJECT TITLE

DRAWING TITLE
04

CHIEF DESIGNER

MASTER DESIGNER

DESIGNER BY

DRAWN BY

CHECK

VERIFY

APPROVE

DESIGN NO

PROJECT NO

CLASSIFICATION



DRAWING NO

SCALE

1:50

DATE

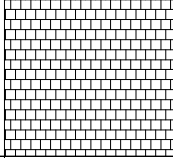

1		
2		

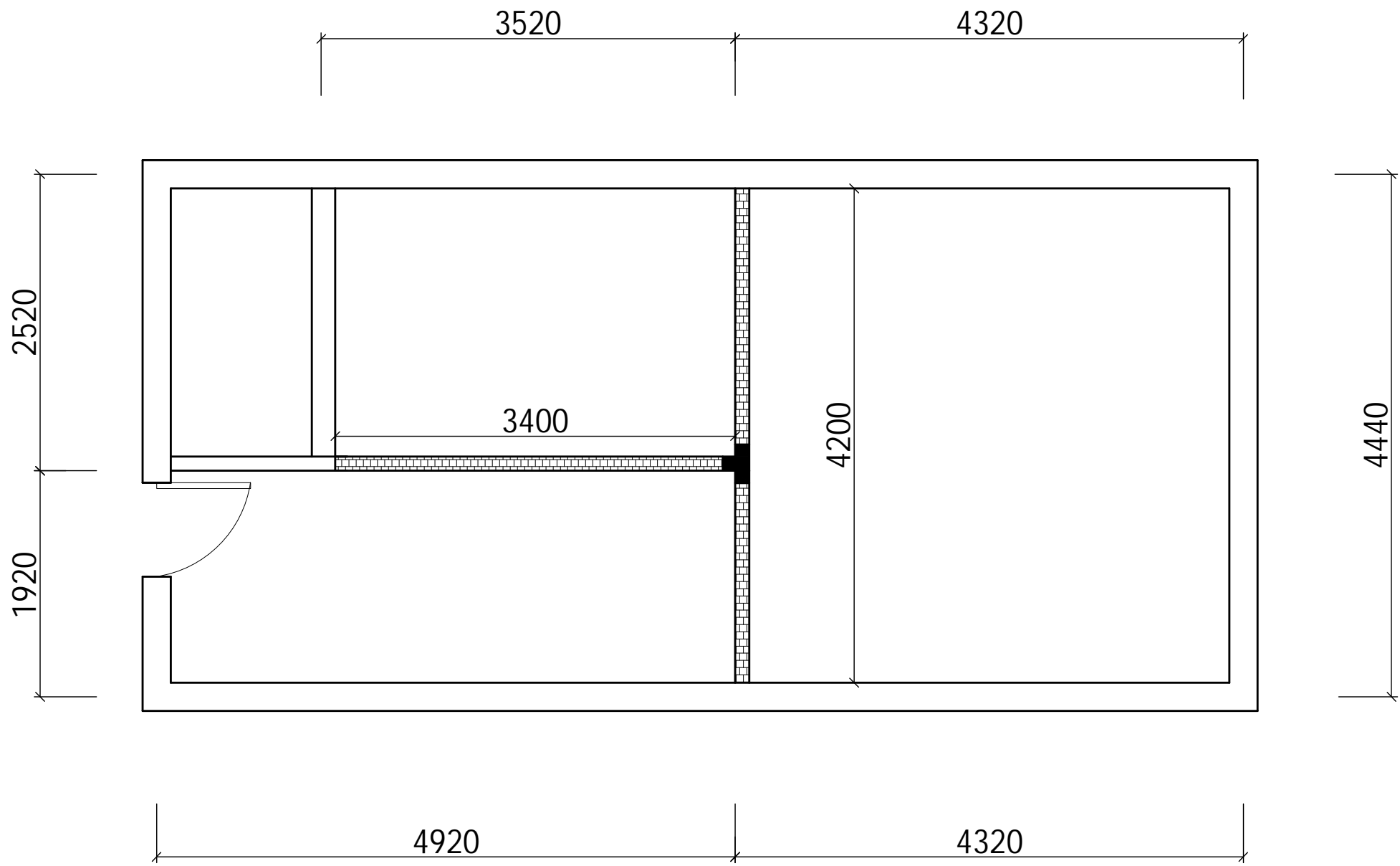

1-1
 2-2
 3-3
 4-4
 5-5
 6-6
 7-7
 8-8
 9-9
 10-10
 11-11
 12-12
 13-13
 14-14
 15-15
 16-16
 17-17
 18-18
 19-19
 20-20
 21-21
 22-22
 23-23
 24-24
 25-25
 26-26
 27-27
 28-28
 29-29
 30-30
 31-31
 32-32
 33-33
 34-34
 35-35
 36-36
 37-37
 38-38
 39-39
 40-40
 41-41
 42-42
 43-43
 44-44
 45-45
 46-46
 47-47
 48-48
 49-49
 50-50
 51-51
 52-52
 53-53
 54-54
 55-55
 56-56
 57-57
 58-58
 59-59
 60-60
 61-61
 62-62
 63-63
 64-64
 65-65
 66-66
 67-67
 68-68
 69-69
 70-70
 71-71
 72-72
 73-73
 74-74
 75-75
 76-76
 77-77
 78-78
 79-79
 80-80
 81-81
 82-82
 83-83
 84-84
 85-85
 86-86
 87-87
 88-88
 89-89
 90-90
 91-91
 92-92
 93-93
 94-94
 95-95
 96-96
 97-97
 98-98
 99-99
 100-100

NOTE
 1.
 2.
 3.

PARTICULARS

CLIENT

PROJECT TITLE

DRAWING TITLE
05

CHIEF DESIGNER	
MASTER DESIGNER	
DESIGNER BY	
DRAWN BY	
CHECK	
VERIFY	
APPROVE	

DESIGN NO	
PROJECT NO	
CLASSIFICATION	
DRAWING NO	
SCALE	1:50
DATE	



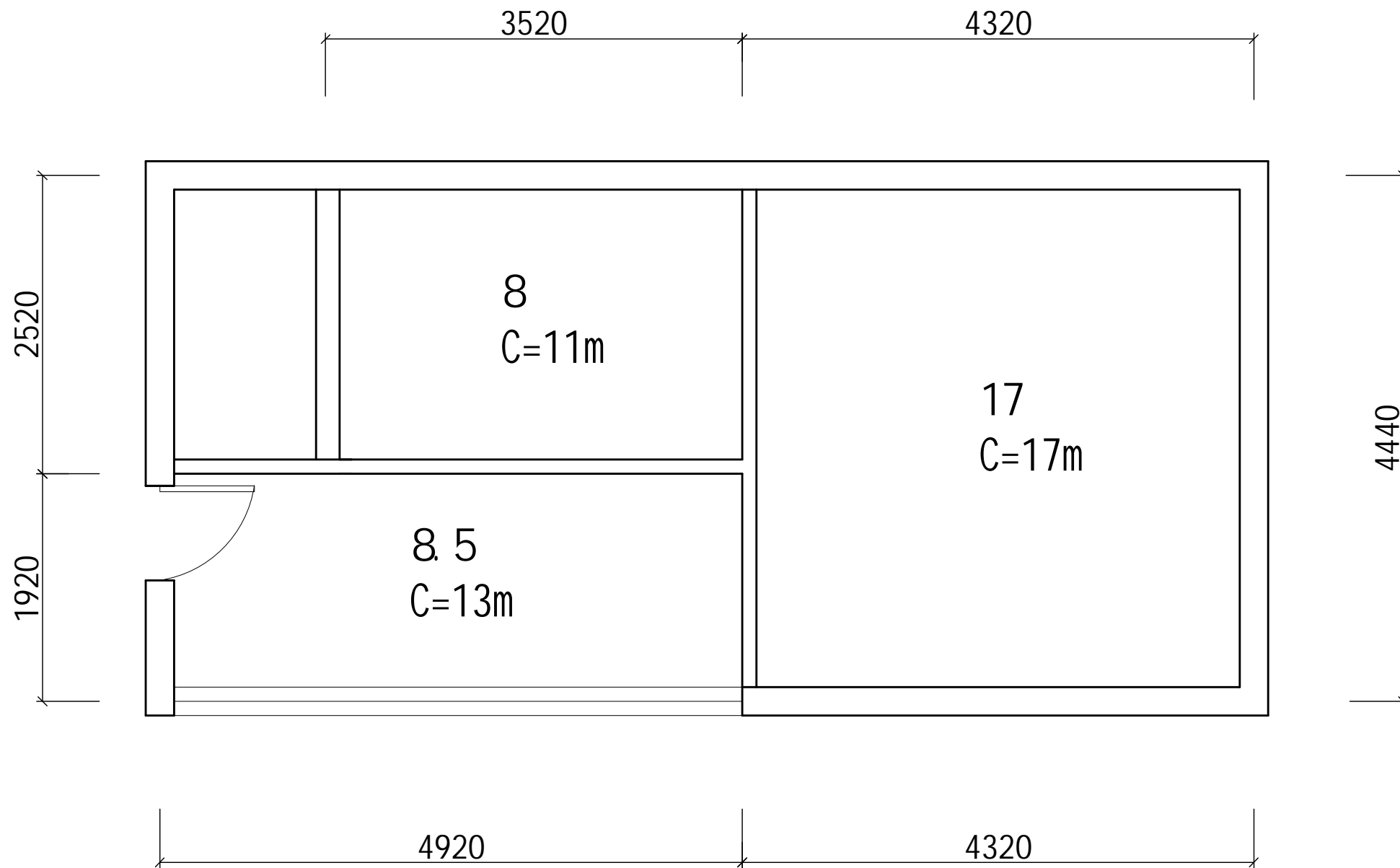

Phonvaine zandhous Architectuur Bvba

NOTE

- 1.
- 2.
- 3.

PARTICULARS

CLIENT

PROJECT TITLE

DRAWING TITLE

06

CHIEF DESIGNER

MASTER DESIGNER

DESIGNER BY

DRAWN BY

CHECK

VERIFY

APPROVE

DESIGN NO

PROJECT NO

CLASSIFICATION

DRAWING NO

SCALE

1:50

DATE



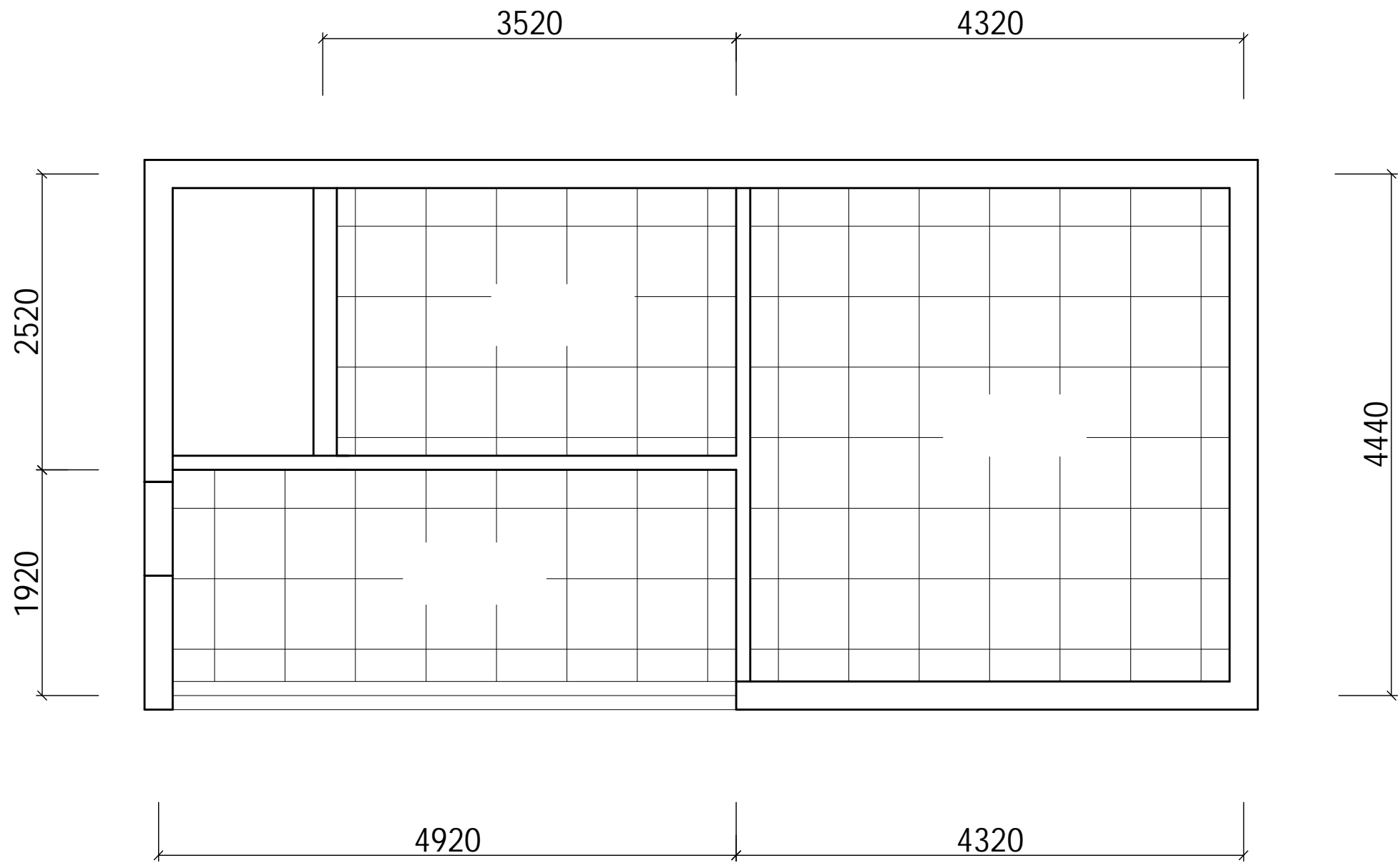

Chennai Engineering College

NOTE

- 1.
- 2.
- 3.

PARTICULARS

CLIENT

PROJECT TITLE

DRAWING TITLE

07

CHIEF DESIGNER

MASTER DESIGNER

DESIGNER BY

DRAWN BY

CHECK

VERIFY

APPROVE

DESIGN NO

PROJECT NO

CLASSIFICATION

DRAWING NO

SCALE

1:50

DATE



1	TP	
2	TV	
3		
4		
5	AC	16A

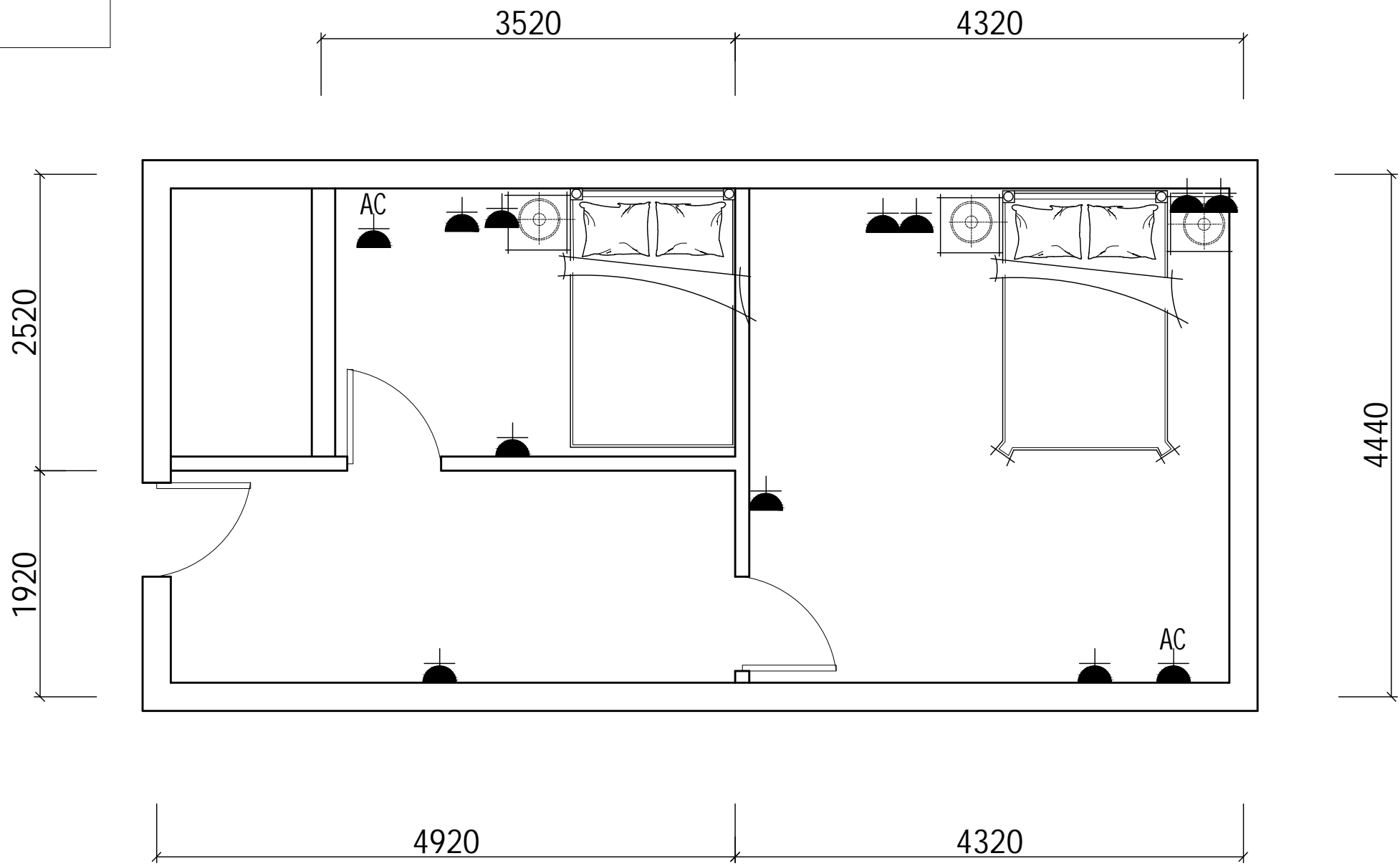

NOTE

- 1.
- 2.
- 3.

PARTICULARS

CLIENT

PROJECT TITLE

DRAWING TITLE

08

CHIEF DESIGNER

MASTER DESIGNER

DESIGNER BY

DRAWN BY

CHECK

VERIFY

APPROVE

DESIGN NO

PROJECT NO

CLASSIFICATION

DRAWING NO

SCALE

1:50

DATE

Chennai Engineering Associates Pvt Ltd



8 LED

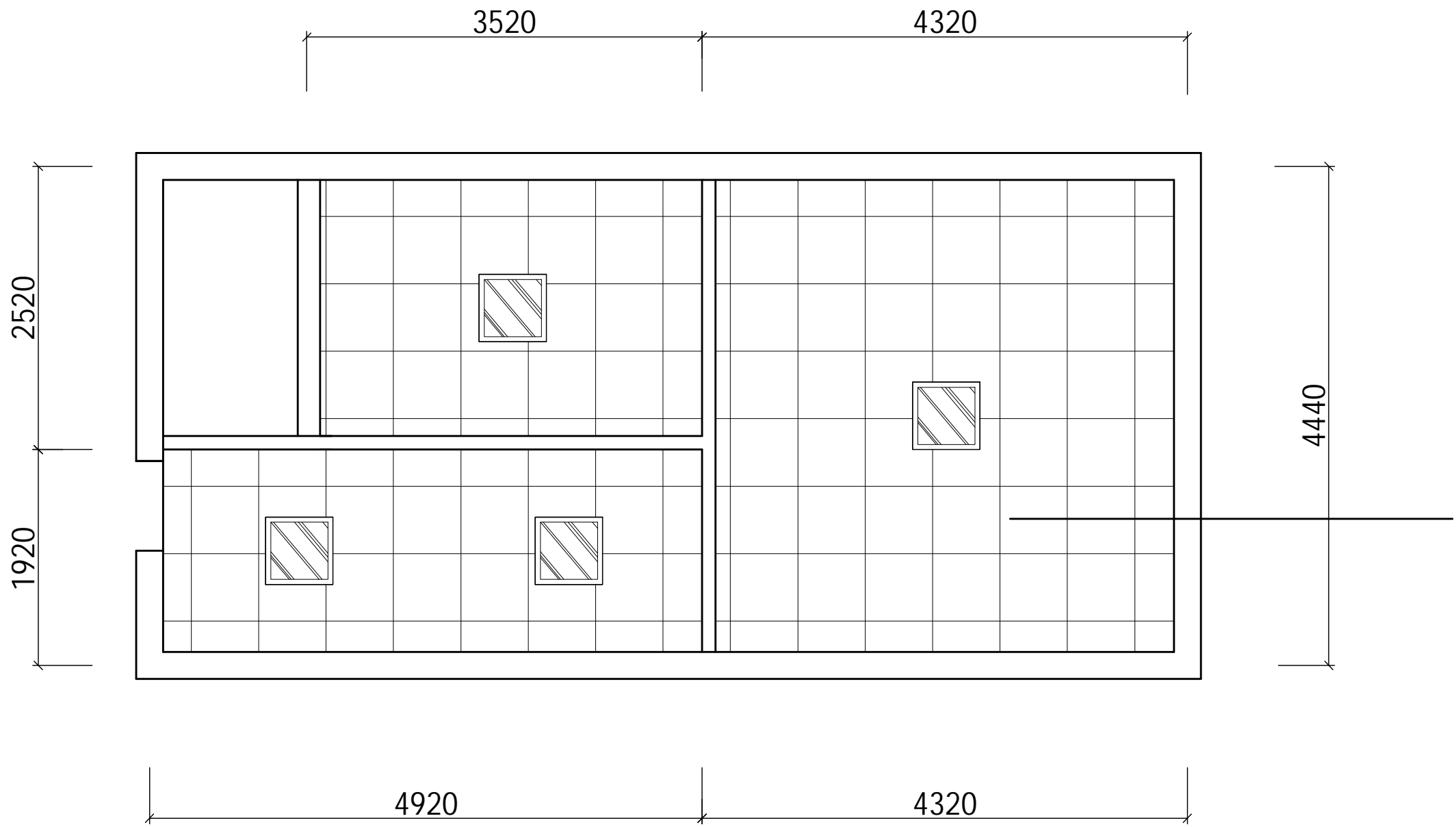

NOTE

- 1.
- 2.
- 3.

PARTICULARS

CLIENT

PROJECT TITLE

DRAWING TITLE

09

CHIEF DESIGNER

MASTER DESIGNER

DESIGNER BY

DRAWN BY

CHECK

VERIFY

APPROVE

DESIGN NO

PROJECT NO

CLASSIFICATION

DRAWING NO

SCALE

1:50

DATE

Chennai Engineering Association Page 1 of 1



1		
2		
3		
4		
5		

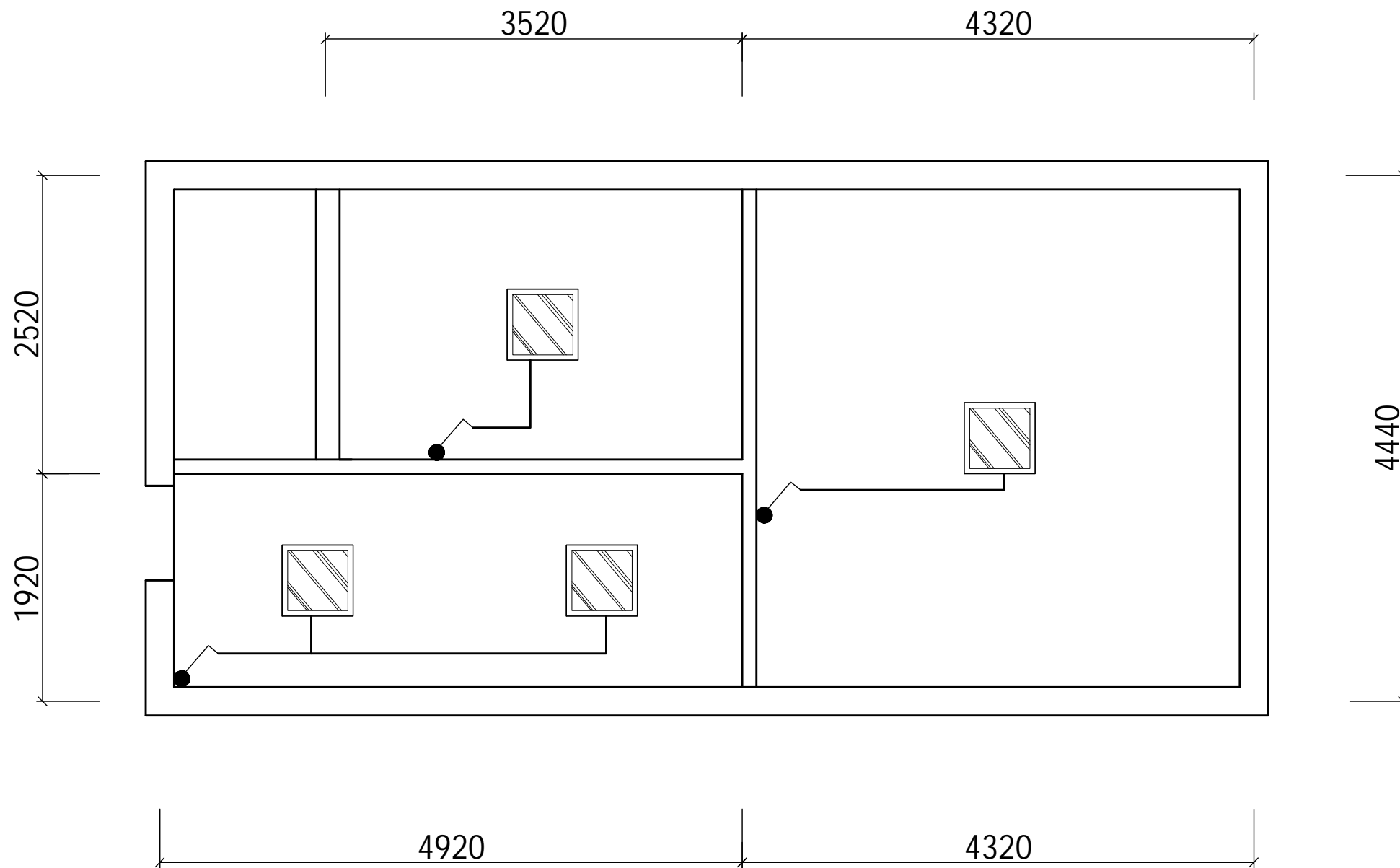

Phonaxine zandhous renovatie project T44

NOTE

- 1.
- 2.
- 3.

PARTICULARS

CLIENT

PROJECT TITLE

DRAWING TITLE

10

CHIEF DESIGNER

MASTER DESIGNER

DESIGNER BY

DRAWN BY

CHECK

VERIFY

APPROVE

DESIGN NO

PROJECT NO

CLASSIFICATION

DRAWING NO

SCALE

1:50

DATE



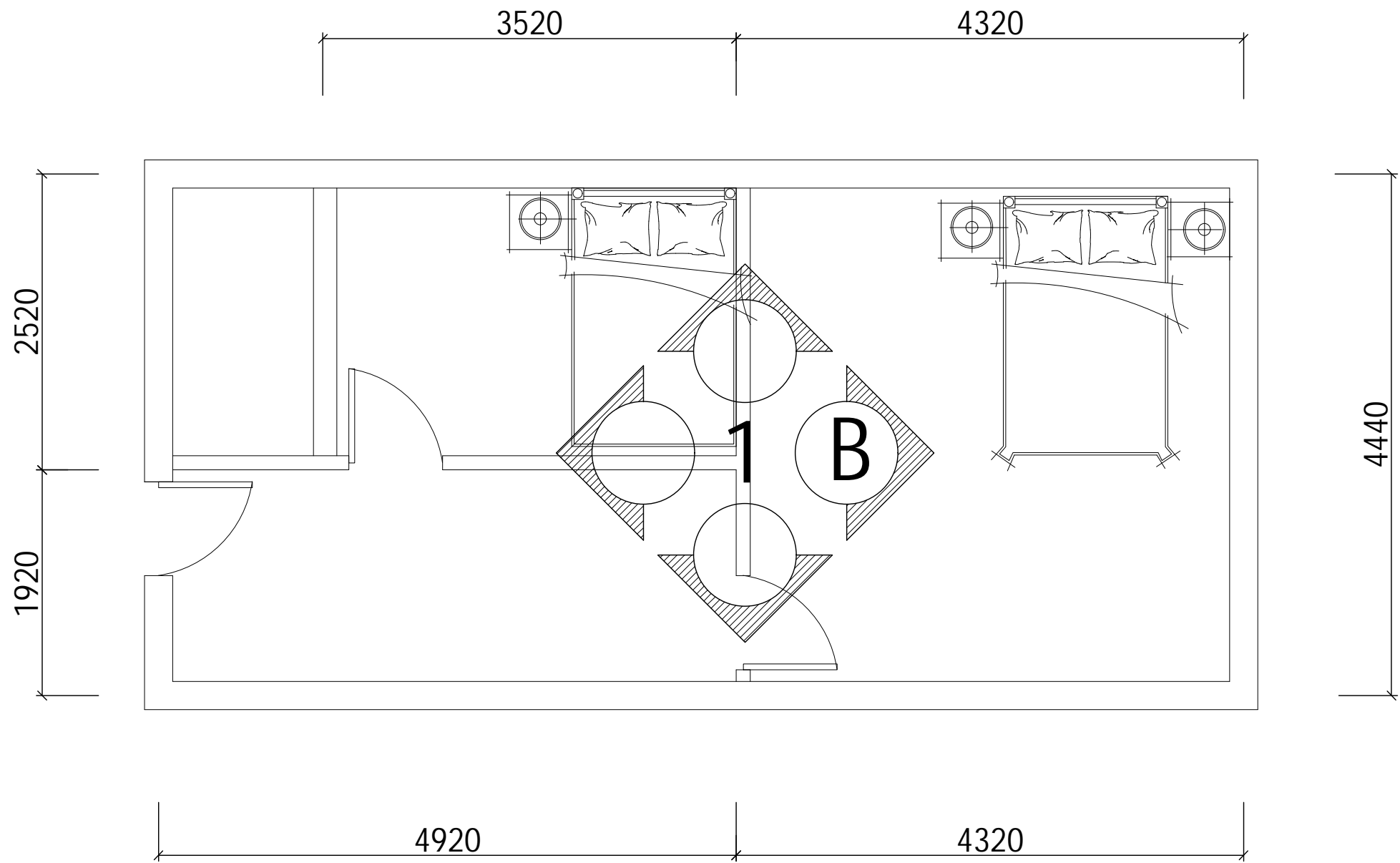

NOTE

- 1.
- 2.
- 3.

PARTICULARS

CLIENT

PROJECT TITLE

DRAWING TITLE

11

CHIEF DESIGNER

MASTER DESIGNER

DESIGNER BY

DRAWN BY

CHECK

VERIFY

APPROVE

DESIGN NO

PROJECT NO

CLASSIFICATION

DRAWING NO

SCALE

1:50

DATE



Phonvaine zandhona Anonattiva dactim I+I

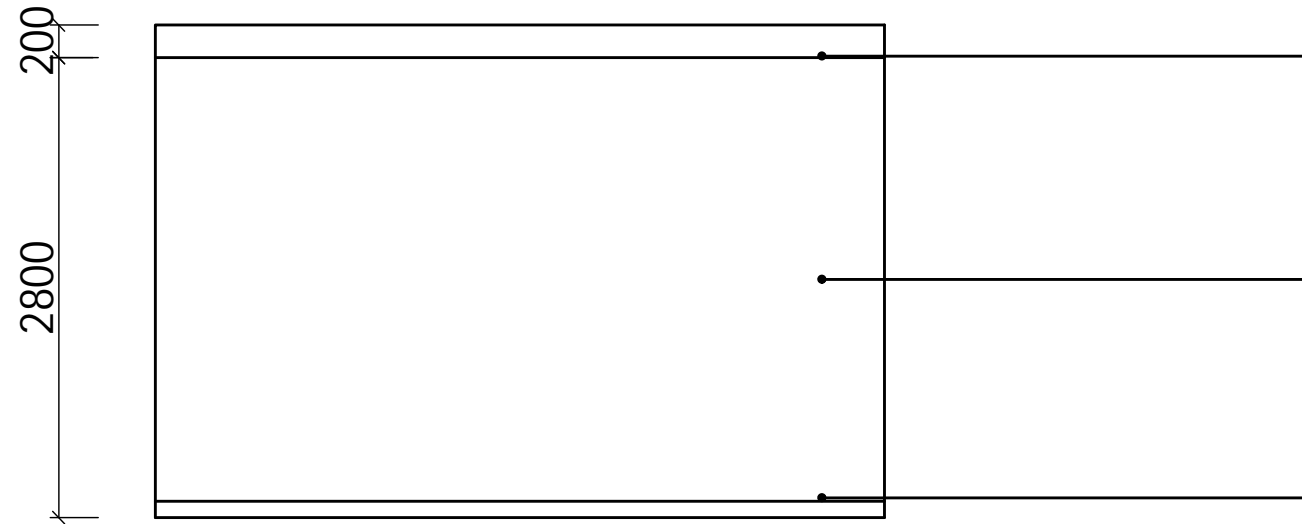
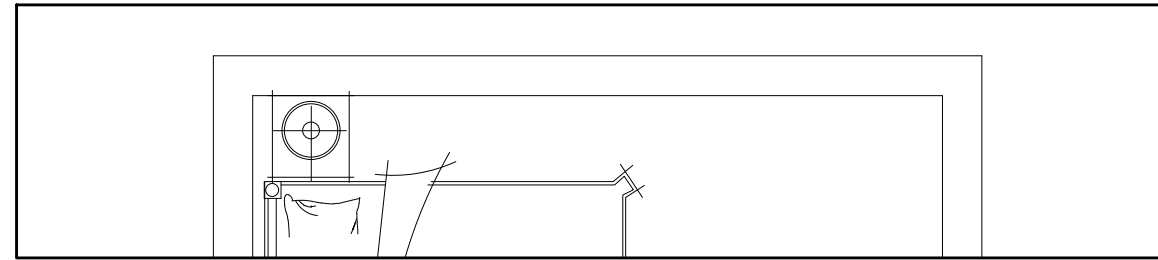

NOTE

- 1.
- 2.
- 3.

PARTICULARS

CLIENT

PROJECT TITLE

DRAWING TITLE
12

CHIEF DESIGNER

MASTER DESIGNER

DESIGNER BY

DRAWN BY

CHECK

VERIFY

APPROVE

DESIGN NO

PROJECT NO

CLASSIFICATION

DRAWING NO

SCALE

1:50

DATE



Phonaxine zandhous innovatie dactim 1+1

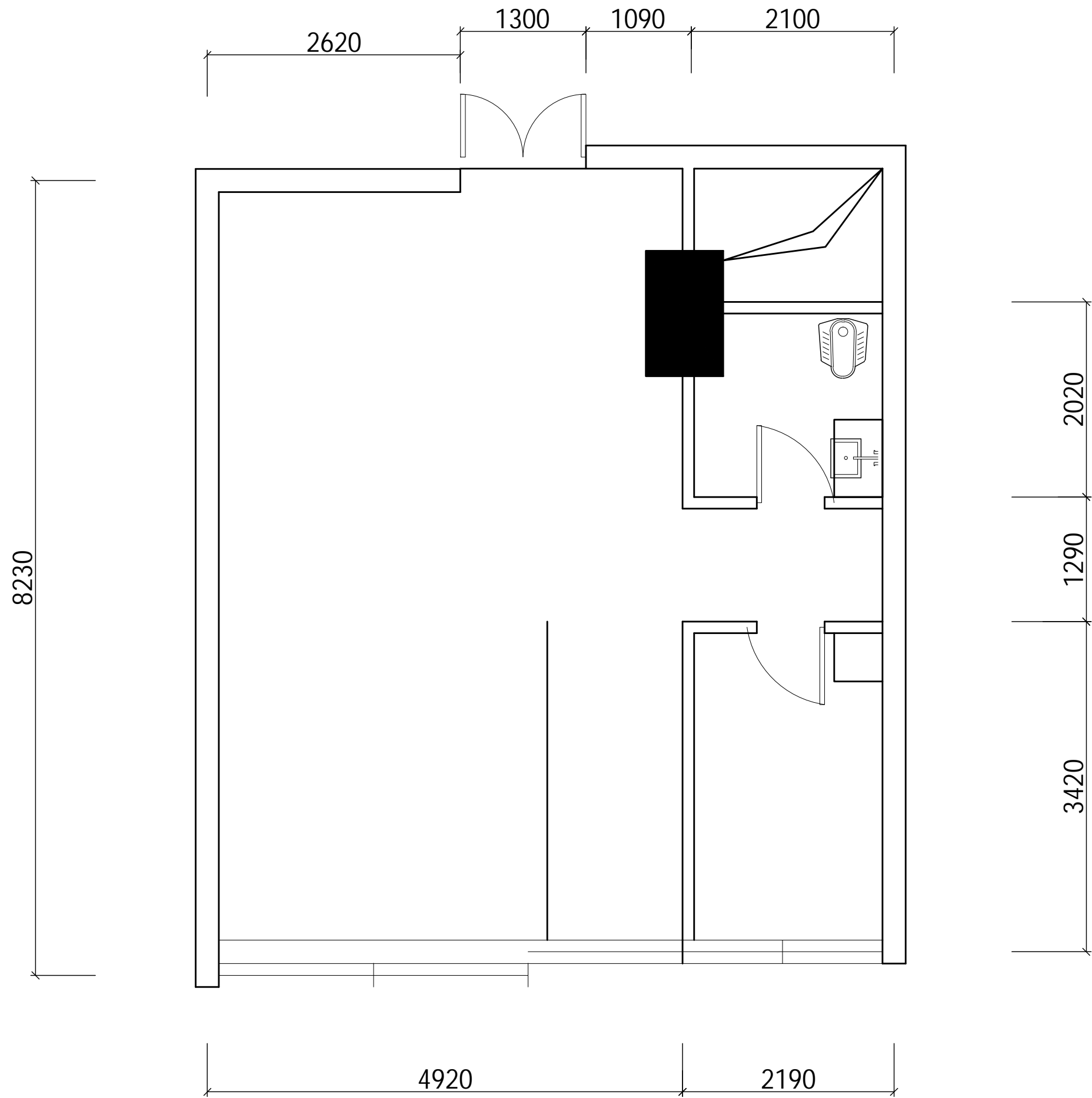

NOTE

- 1.
- 2.
- 3.

PARTICULARS

CLIENT

PROJECT TITLE

DRAWING TITLE

13

CHIEF DESIGNER

MASTER DESIGNER

DESIGNER BY

DRAWN BY

CHECK

VERIFY

APPROVE

DESIGN NO

PROJECT NO

CLASSIFICATION

DRAWING NO

SCALE

1:50

DATE



Chennai zandana Innovation Action 1+1

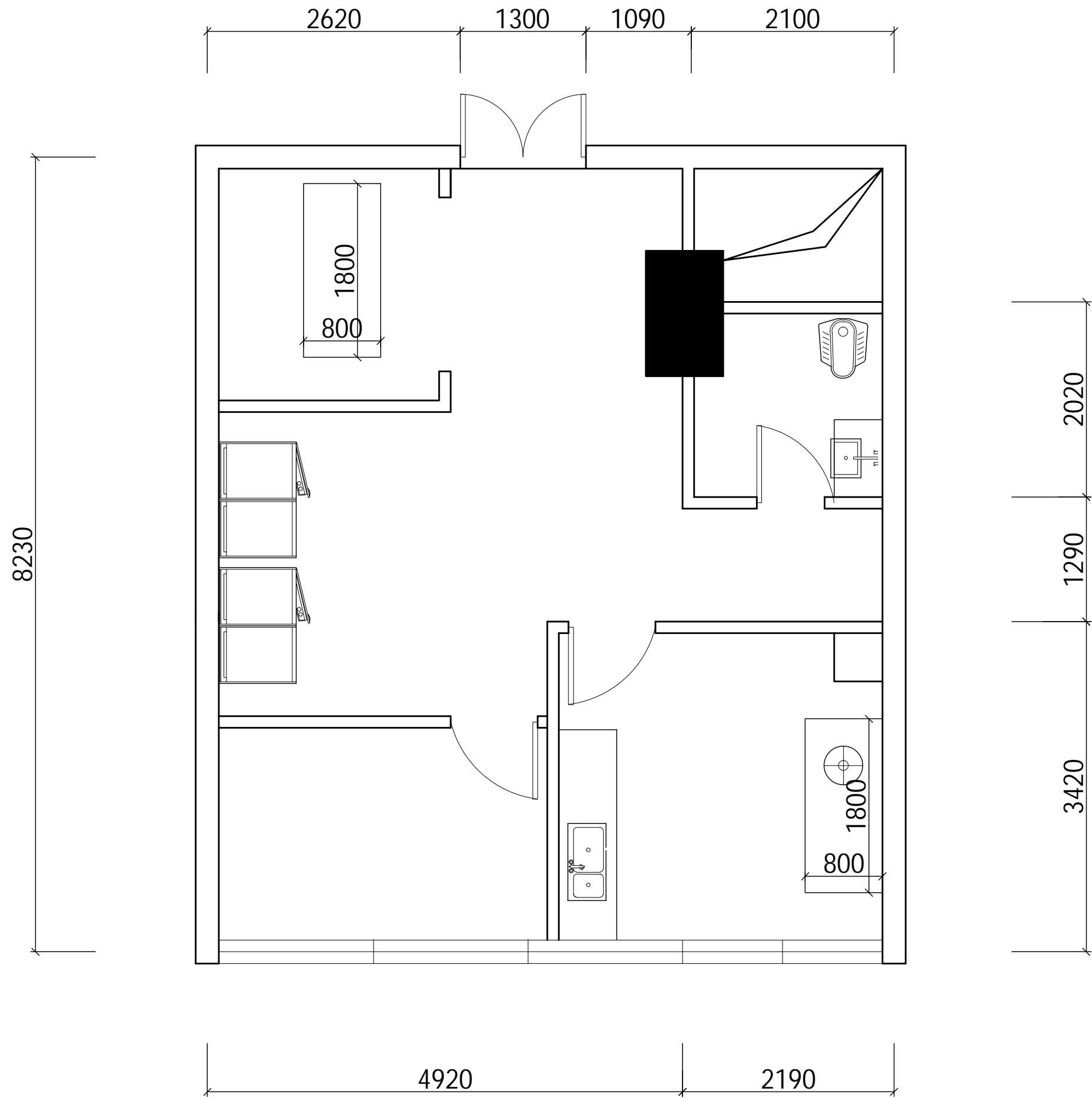

NOTE

- 1.
- 2.
- 3.

PARTICULARS

CLIENT

PROJECT TITLE

DRAWING TITLE

14

CHIEF DESIGNER

MASTER DESIGNER

DESIGNER BY

DRAWN BY

CHECK

VERIFY

APPROVE

DESIGN NO

PROJECT NO

CLASSIFICATION

DRAWING NO

SCALE

1:50

DATE

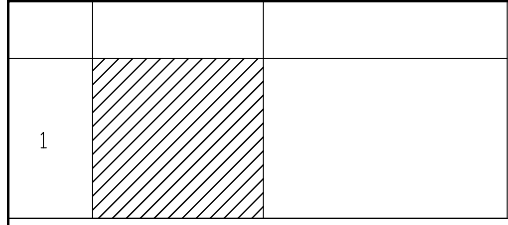

8230

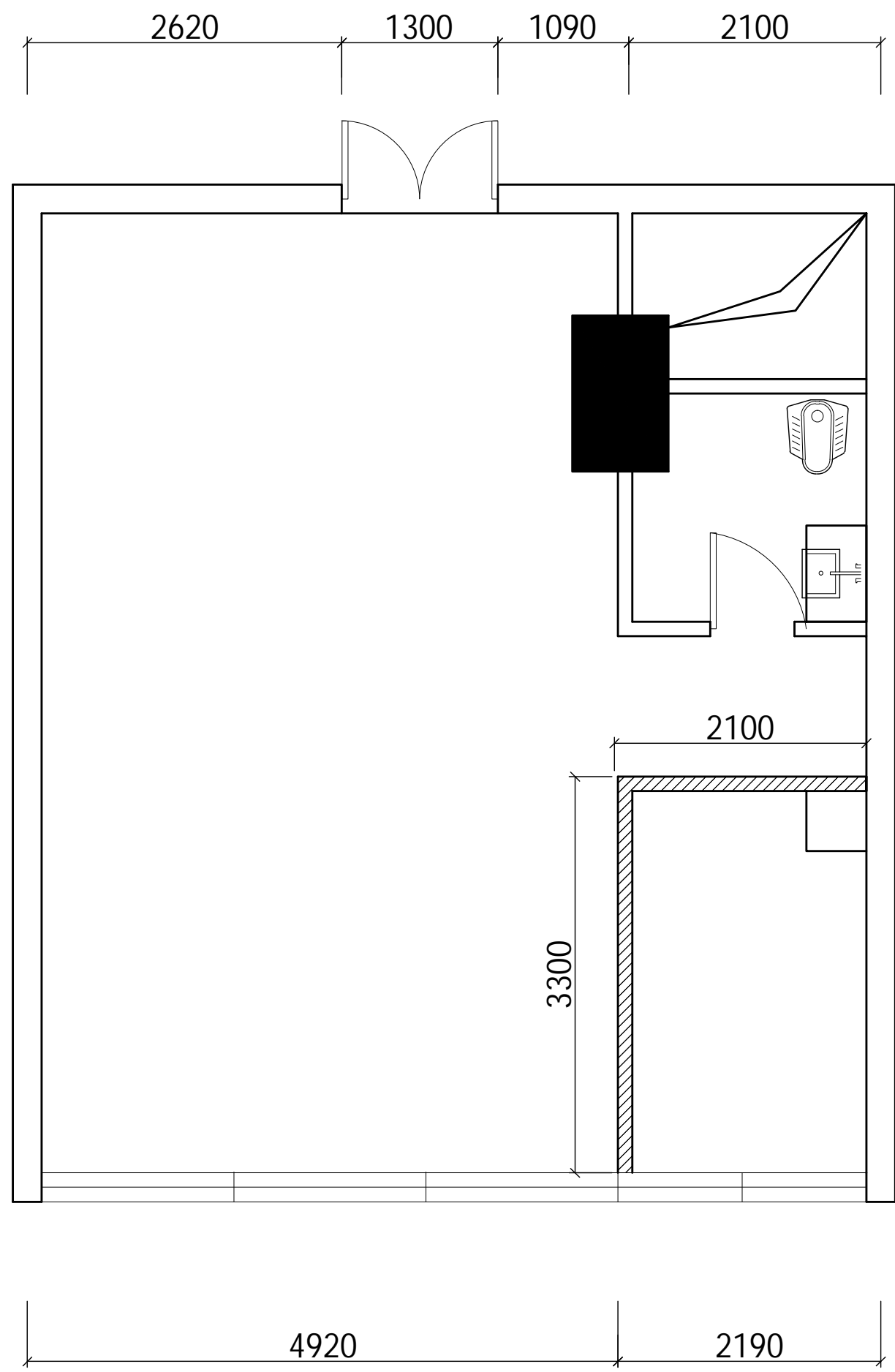

2020
1290
3420

Phonaxine zambanae Anonimus Jecim 144

NOTE

- 1.
- 2.
- 3.

PARTICULARS

CLIENT

PROJECT TITLE

DRAWING TITLE
15

CHIEF DESIGNER

MASTER DESIGNER

DESIGNER BY

DRAWN BY

CHECK

VERIFY

APPROVE

DESIGN NO

PROJECT NO

CLASSIFICATION

DRAWING NO

SCALE

1:50

DATE



1	
2	

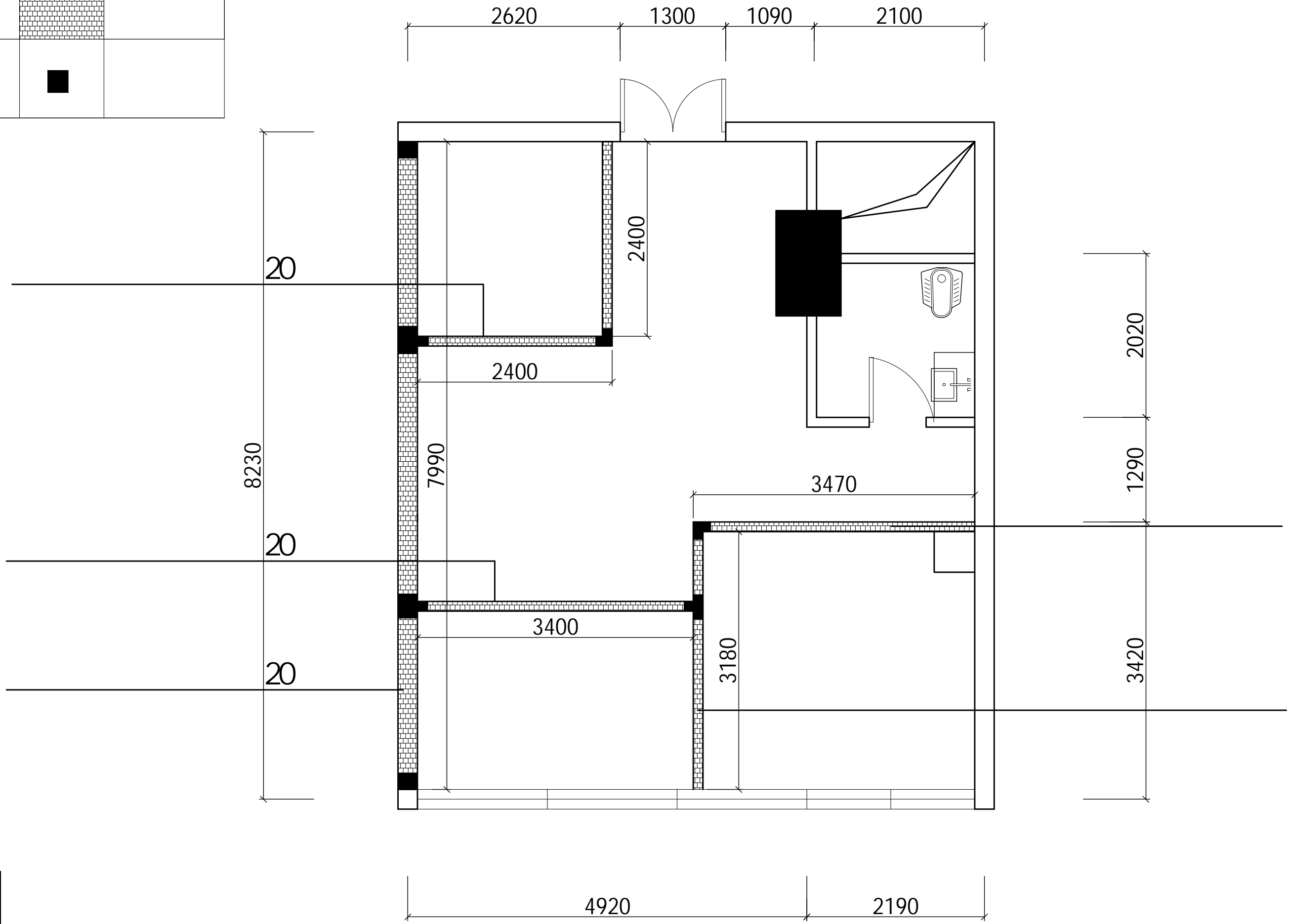

Thammasat Engineering Department

NOTE

- 1.
- 2.
- 3.

PARTICULARS

CLIENT

PROJECT TITLE

DRAWING TITLE

16

CHIEF DESIGNER

MASTER DESIGNER

DESIGNER BY

DRAWN BY

CHECK

VERIFY

APPROVE

DESIGN NO

PROJECT NO

CLASSIFICATION

DRAWING NO

SCALE

1:50

DATE



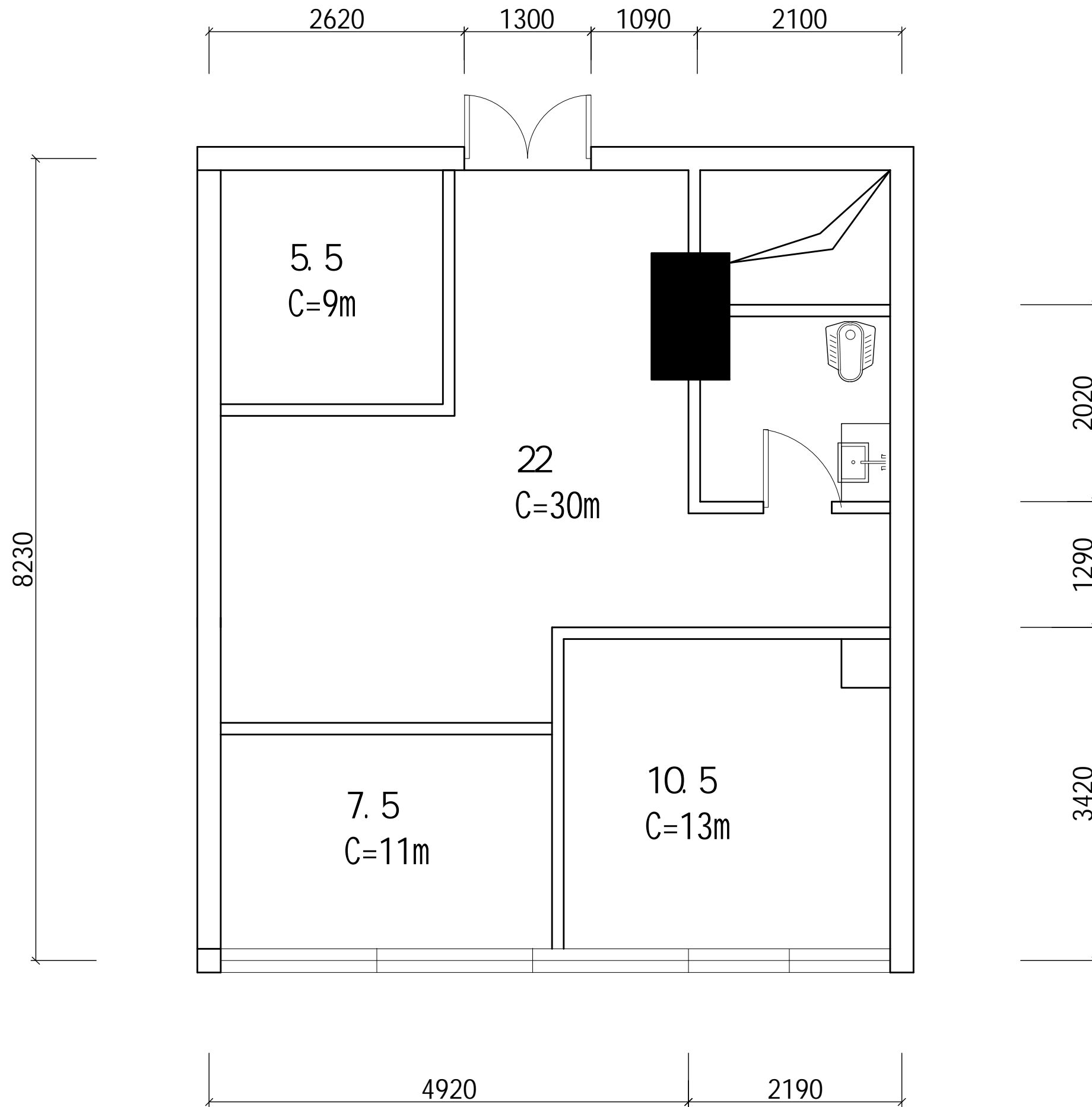

Chennai zandana Innovation Pvt Ltd

NOTE

- 1.
- 2.
- 3.

PARTICULARS

CLIENT

PROJECT TITLE

DRAWING TITLE

17

CHIEF DESIGNER

MASTER DESIGNER

DESIGNER BY

DRAWN BY

CHECK

VERIFY

APPROVE

DESIGN NO

PROJECT NO

CLASSIFICATION

DRAWING NO

SCALE

1:50

DATE



Chuvashina zombhona Anonovativu Jactum 1+1

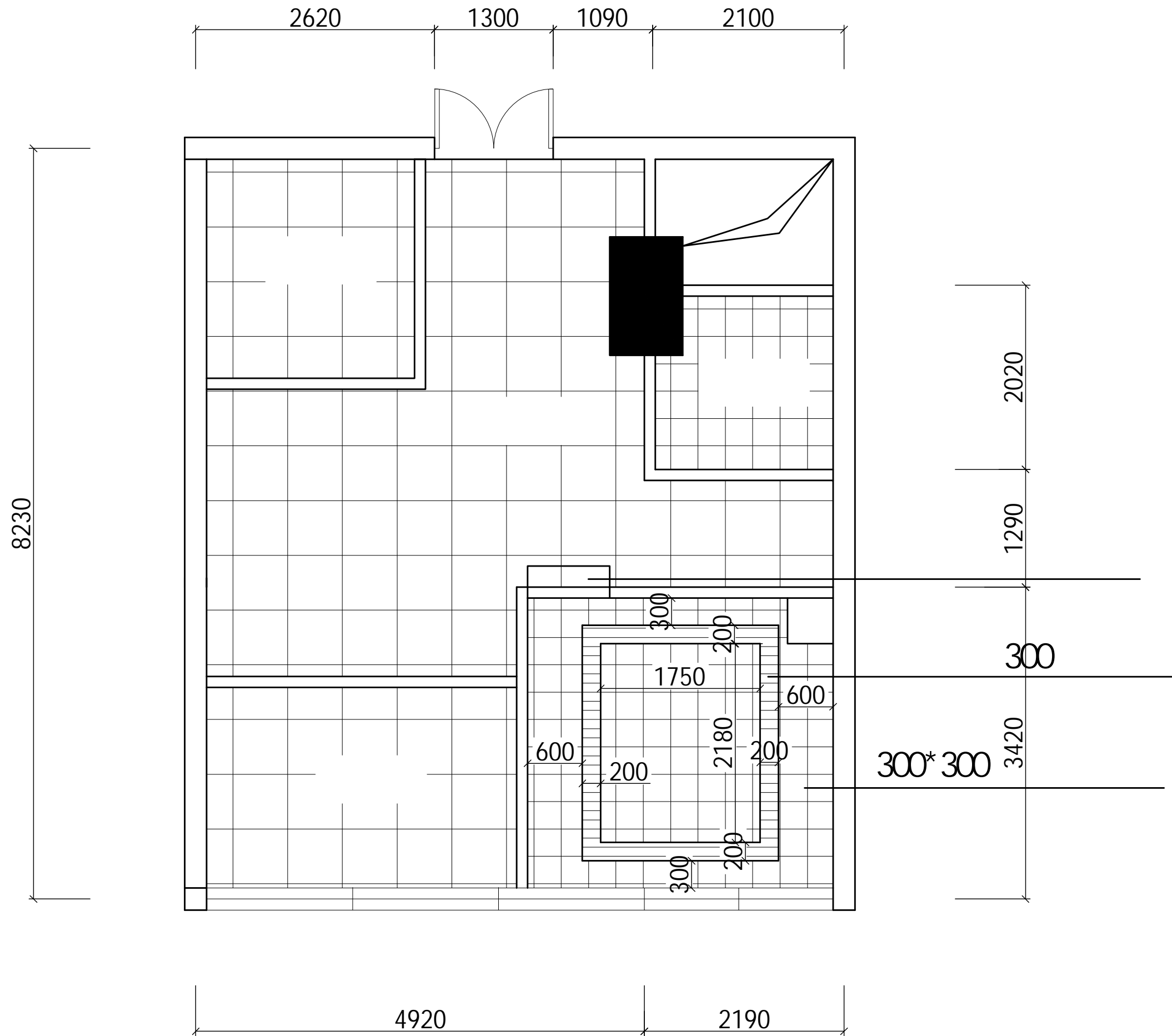

NOTE

- 1.
- 2.
- 3.

PARTICULARS

CLIENT

PROJECT TITLE

DRAWING TITLE

18

CHIEF DESIGNER

MASTER DESIGNER

DESIGNER BY

DRAWN BY

CHECK

VERIFY

APPROVE

DESIGN NO

PROJECT NO

CLASSIFICATION

DRAWING NO

SCALE

1:50

DATE

1	TP	
2	TV	
3		
4		
5	AC	16A

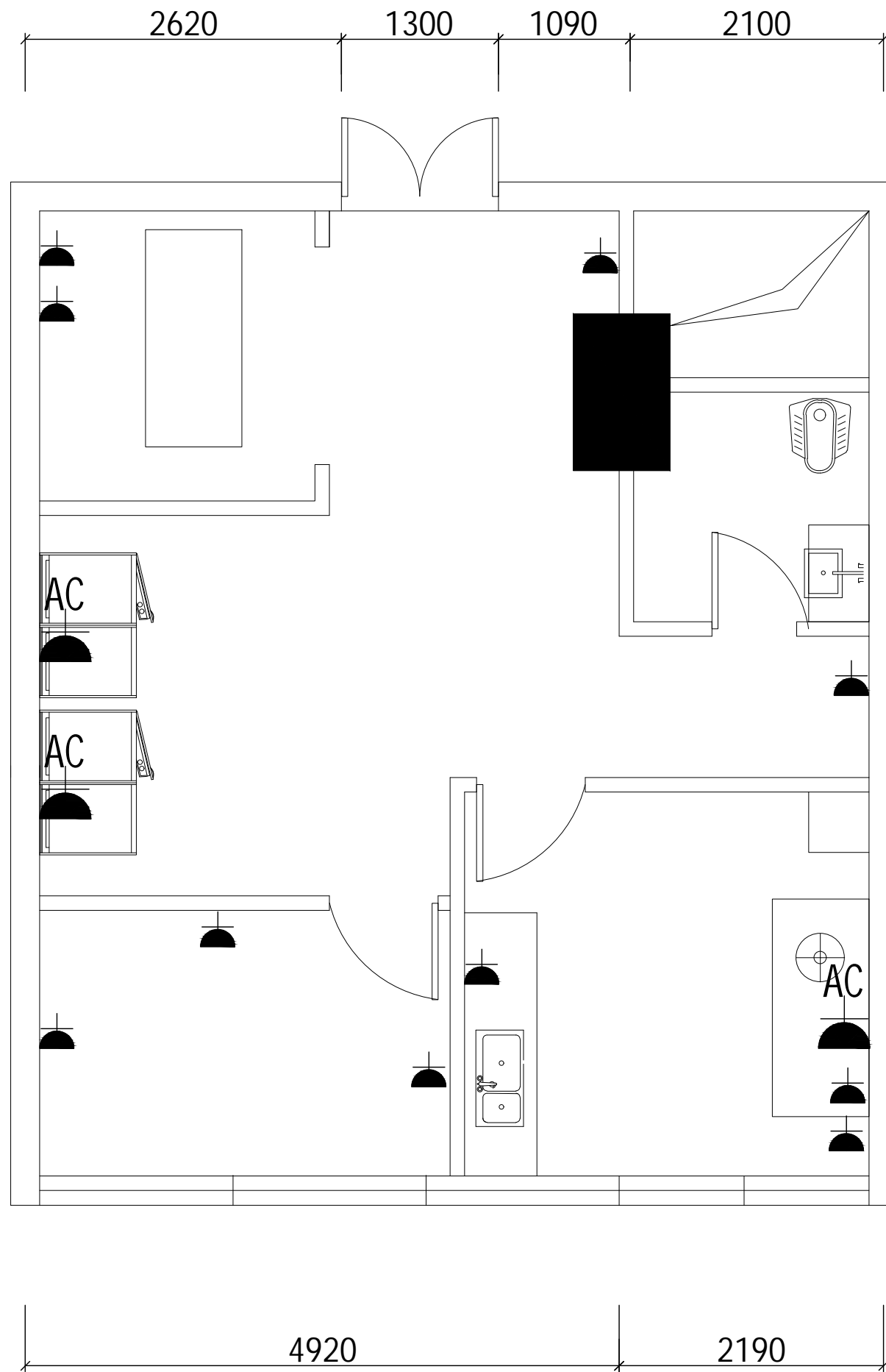

Phonaxine zambana dnoovativu dactim 1+1

NOTE

- 1.
- 2.
- 3.

PARTICULARS

CLIENT

PROJECT TITLE

DRAWING TITLE

19

CHIEF DESIGNER

MASTER DESIGNER

DESIGNER BY

DRAWN BY

CHECK

VERIFY

APPROVE

DESIGN NO

PROJECT NO

CLASSIFICATION

DRAWING NO

SCALE

1:50

DATE

8 LED

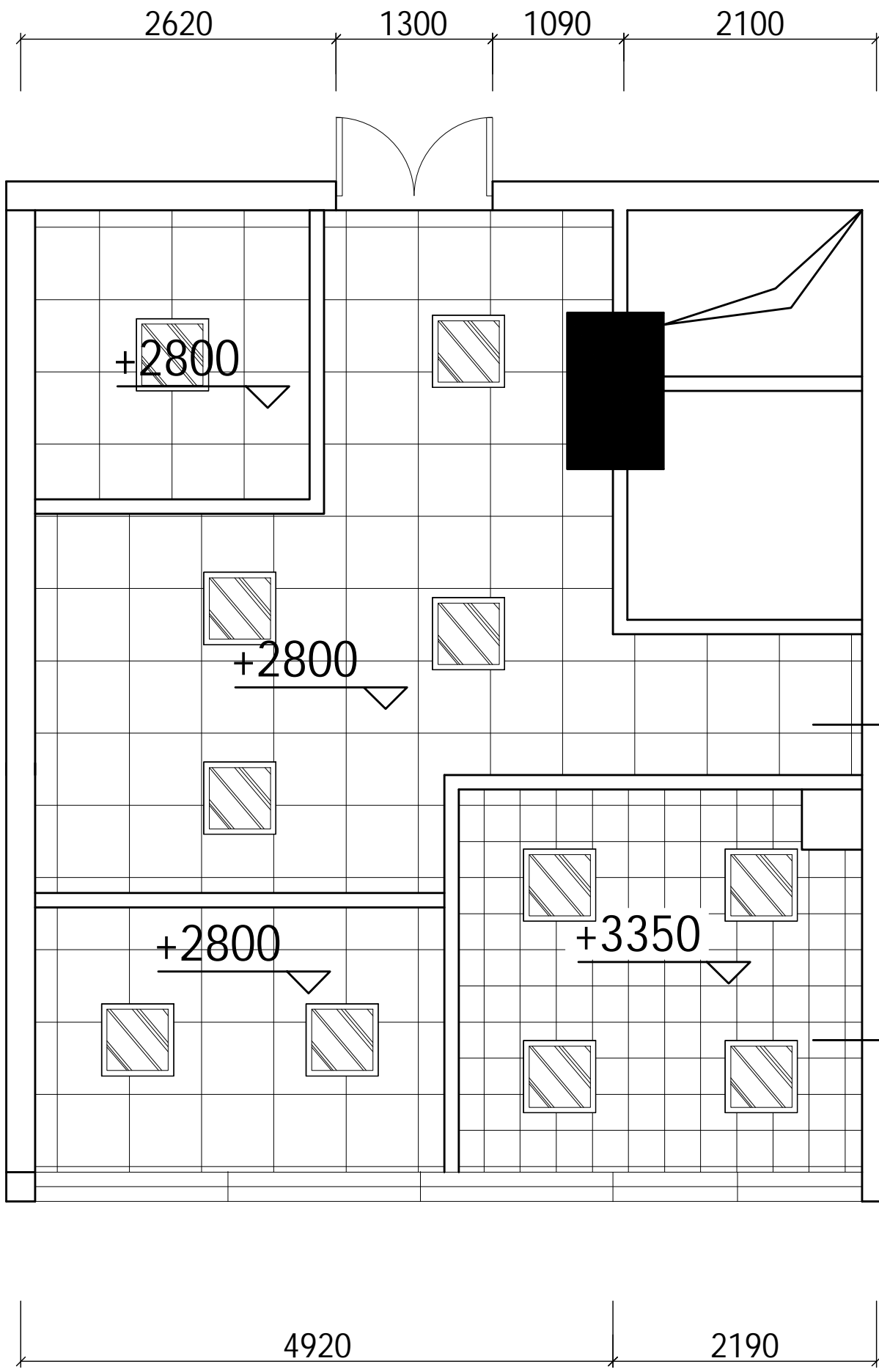

NOTE

- 1.
- 2.
- 3.

PARTICULARS

CLIENT

PROJECT TITLE

DRAWING TITLE

20

CHIEF DESIGNER

MASTER DESIGNER

DESIGNER BY

DRAWN BY

CHECK

VERIFY

APPROVE

DESIGN NO

PROJECT NO

CLASSIFICATION

DRAWING NO

SCALE

1:50

DATE

Chennai zandana Anantiva dactm 1+1



1		
2		
3		
4		
5		

8230

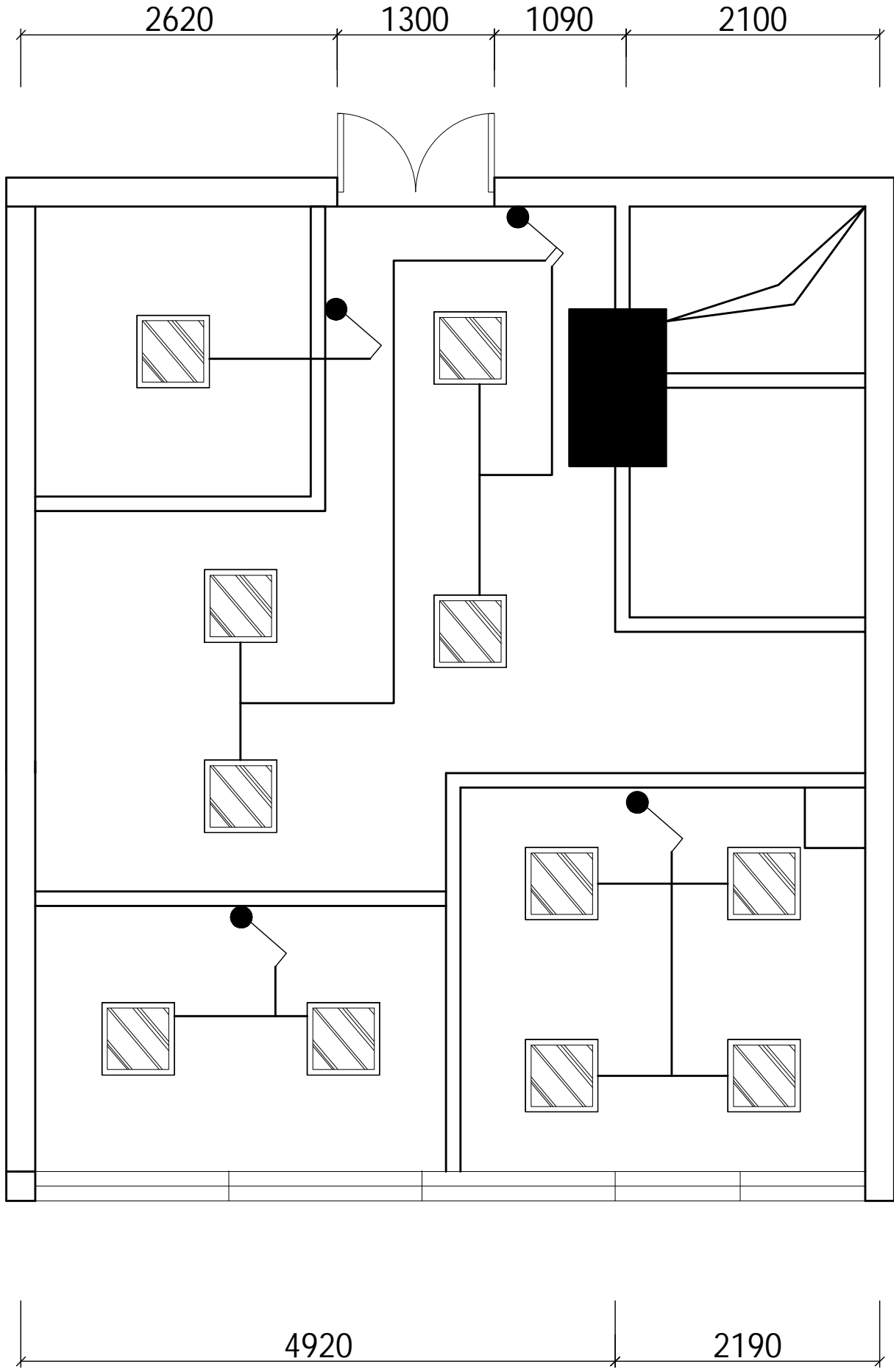

2020
1290
3420

Phonaxine zandhous Innovatieve dactim 1+1

NOTE

- 1.
- 2.
- 3.

PARTICULARS

CLIENT

PROJECT TITLE

DRAWING TITLE

21

CHIEF DESIGNER

MASTER DESIGNER

DESIGNER BY

DRAWN BY

CHECK

VERIFY

APPROVE

DESIGN NO

PROJECT NO

CLASSIFICATION

DRAWING NO

SCALE

1:50

DATE



Phonaxine zandhous innovatie dactim 1+1

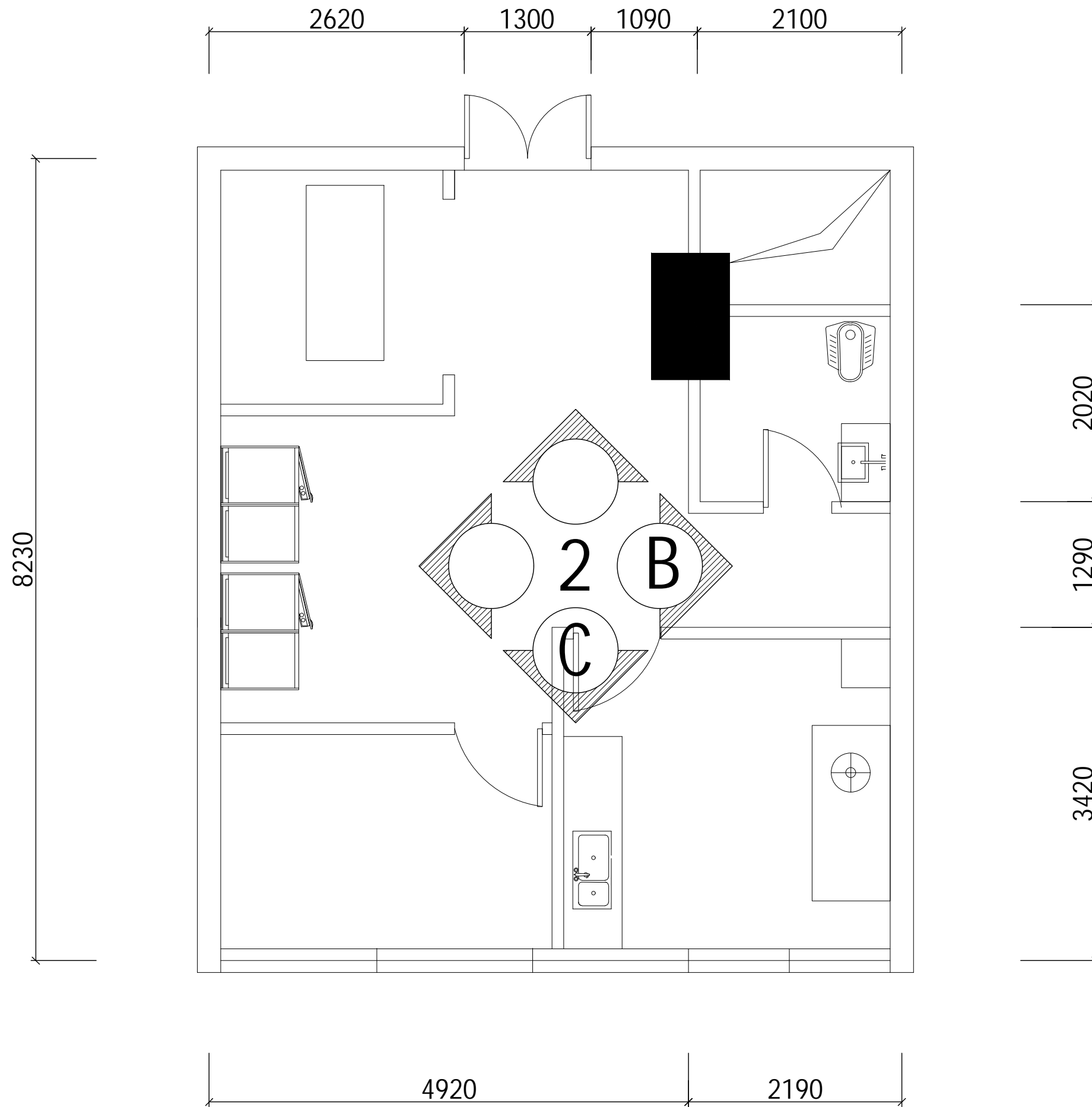

NOTE

- 1.
- 2.
- 3.

PARTICULARS

CLIENT

PROJECT TITLE

DRAWING TITLE

22

CHIEF DESIGNER

MASTER DESIGNER

DESIGNER BY

DRAWN BY

CHECK

VERIFY

APPROVE

DESIGN NO

PROJECT NO

CLASSIFICATION

DRAWING NO

SCALE

1:50

DATE

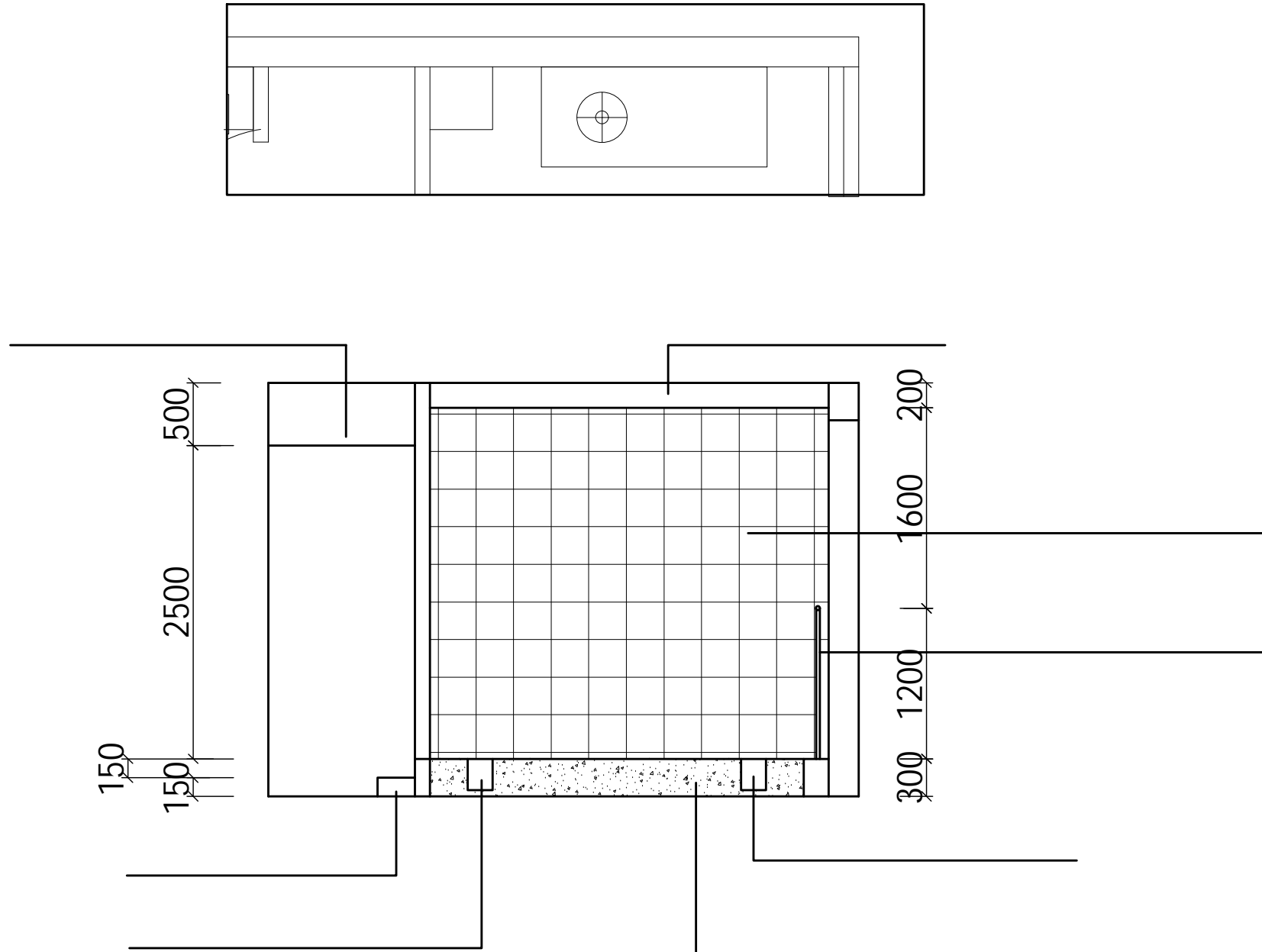

NOTE

- 1.
- 2.
- 3.

PARTICULARS

CLIENT

PROJECT TITLE

DRAWING TITLE

23

CHIEF DESIGNER

MASTER DESIGNER

DESIGNER BY

DRAWN BY

CHECK

VERIFY

APPROVE

DESIGN NO

PROJECT NO

CLASSIFICATION

DRAWING NO

SCALE

1:50

DATE



Phonaxine zandhous innovatie dachm 1+1

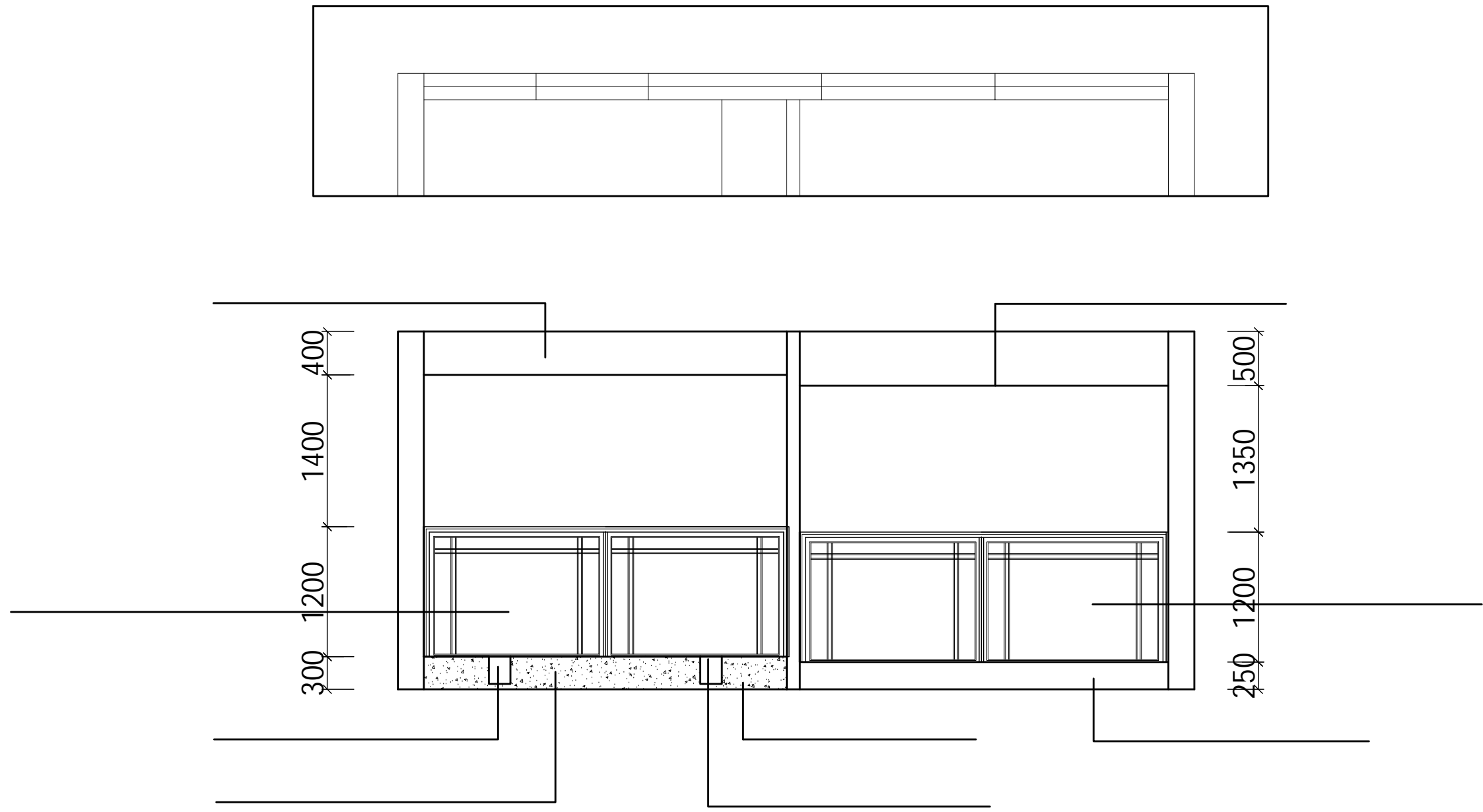

NOTE

- 1.
- 2.
- 3.

PARTICULARS

CLIENT

PROJECT TITLE

DRAWING TITLE

24

CHIEF DESIGNER

MASTER DESIGNER

DESIGNER BY

DRAWN BY

CHECK

VERIFY

APPROVE

DESIGN NO

PROJECT NO

CLASSIFICATION

DRAWING NO

SCALE

1:50

DATE

